

# Data Sheet



Article number: 021816011329

Description: Clamp with bracket and rubber  
SPGU 6011. 329/30 SK

## Measures

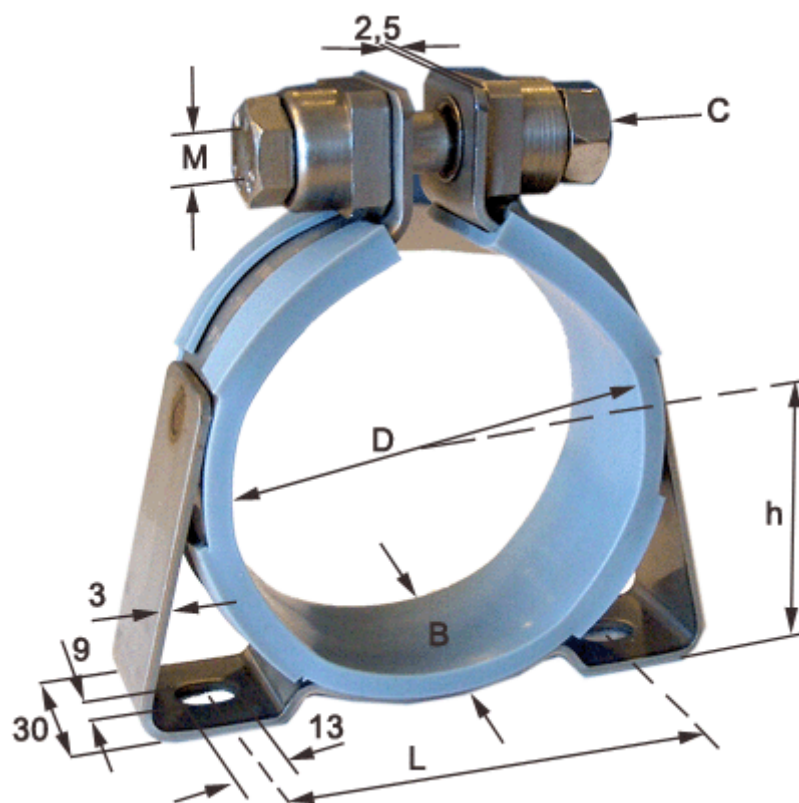

C (screw type) = SK hexagon screw

Diameter D = 329

h = 173

L = 280

Width B = 30